

Coverage Measurement Software ROMES3

Acquisition, analysis and visualization of data in coverage measurements

- ◆ Recording/viewing data from 1 to 4 (15) test mobiles simultaneously for quick and easy network comparisons
- ◆ Checking progress and quality of measurements
- ◆ Selecting and sizing windows at any time, even during measurement or replay
- ◆ Replaying recorded data (or selected parts) with choice of views
- ◆ Following position on map during measurement tour or replay
- ◆ Import user-own scanned maps or vector maps
- ◆ Data converter for ROSEVAL evaluation software and prediction tools available
- ◆ Integrated GIS (geographical information system) tool
- ◆ Supports test mobiles (GSM, CDMA, UMTS, radio/TV/DAB/DVB), Rohde & Schwarz test receivers (ESVD/B, ES-PC, ESPI, FSP, EB200, ESMB, EFA-T, DVQ, DVM), navigation systems (GPS Placer, TP, NMEA)
- ◆ Integrated database
- ◆ Masterslave function
- ◆ Search function
- ◆ Interference measurement

Acquisition, analysis and visualization of data...

Communication with seamless coverage and without interference, reliable data transmission at an acceptable speed – these and many other quality criteria are decisive for the success of a mobile-radio network on the market. To enable network operators to provide the required quality – and thus be commercially successful – Rohde&Schwarz offers with its TS995x product line hardware and software for all standards available today. Common to all systems is the modular and versatile Measurement Software ROMES 3.

Complete solutions for communication networks

Coverage measurement systems from Rohde&Schwarz accommodate virtually all fields of application: network planning, installation and optimization through to network servicing and monitoring. Measured data acquisition, test signal generation and result analysis are carried out comprehensively, fast and with high precision. The new measurement software ROMES 3 provides the platform for all these systems, which allow most network problems to be detected and analyzed. ROMES 3 collects data fast and conveniently during test tours and offers versatile visualization to meet user's requirements.

Universal and future-proof

Modular concept

ROMES 3 is based on a modular system concept, allowing any type of data to be collected and analyzed. Any sensor (e.g. test receiver, test mobile or GPS receiver) capable of result transfer to a PC can be used. This opens up a wide range of use, from measurements in mobileradio and DAB/DVB networks through to almost any kind of exotic application. The modular concept enables the implementation of very small systems and high-performance test systems alike. And it makes the software future-proof, as it can easily be extended to accommodate upcoming technologies (e.g. UMTS, WCDMA).

The core of the application can handle any kind of data and routes the incoming data stream to the appropriate software modules. All signals detected are stored on hard disk immediately on arrival at the core and visualized in a form meeting the user's requirements.

Apart from the core, there are numerous modules by which software can be extended to suit a given application. The modules are all available as options, so custom solutions can be configured fast. For example, different transmission technologies can be combined and/or multiply provided in a measurement system (e.g. a CDMA, two GSM and an ETACS mobile, a test receiver and GPS).

Integrated database

ROMES 3 has an integrated database that allows customer-specific data to be included in result analysis. Results can be automatically linked to database contents, for example to a list of all base stations, from which the software then extracts the stations used.

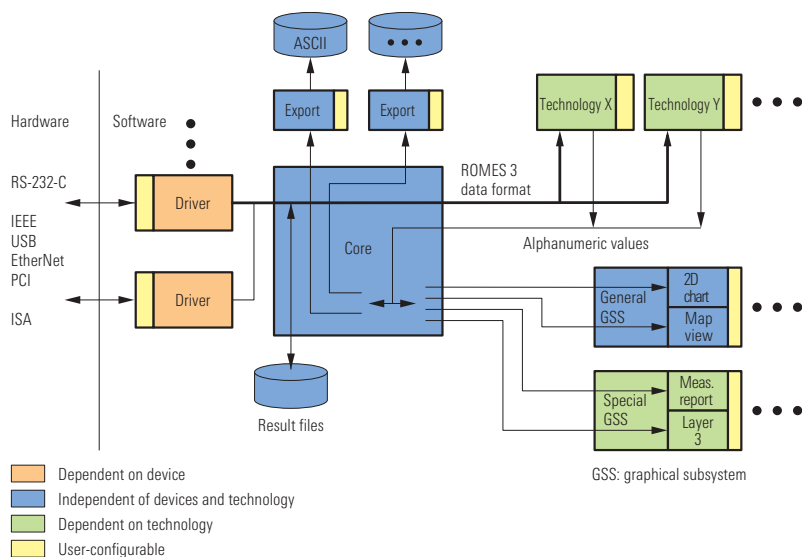

The modular concept of ROMES 3 allows both very small systems and complex high-performance test systems to be implemented

... in coverage measurements

Simple, intuitive user interface

The core of ROMES3 also comprises the major part of the user interface, which offers many special features:

- ◆ Central configuration of all signals, events and modules known in the system
- ◆ Automatic loading of working environments last stored upon restart of the application
- ◆ Online configuration of views via context menus, so display parameters can be added or removed during measurement
- ◆ Multiview technique
- ◆ User-configurable shortcuts
- ◆ Context-sensitive online help, etc

Pipes between modules enable new applications

ROMES3 provides a simple yet efficient interface allowing communication between different modules via pipes (pipes are communication links between independent software modules). This is a precondition for master/slave operation, where one module drives another. The pipe concept opens up versatile applications, for example simultaneous testing of data or fax transmissions (see box) or recording of data measured with the test mobile.

Operating principle of pipe concept

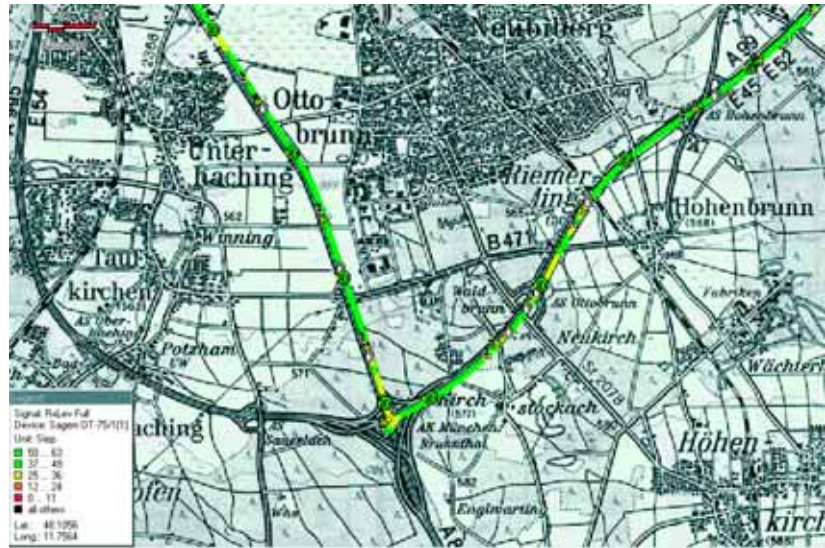
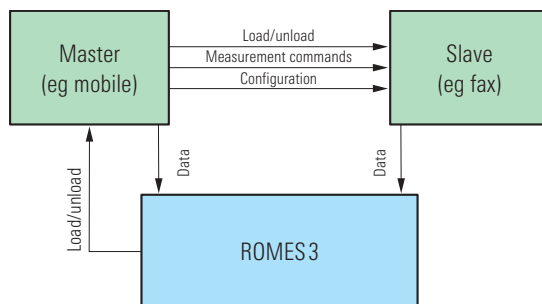

Display of level along a tour with indication of hanover and connect/disconnect events

Analysis tools of ROMES3

Apart from efficient measured-data acquisition, ROMES3 offers comprehensive functionality for the localization of problems so that solutions can be found quickly.

Search functions

Replay, a powerful analysis and search function, is an integral part of the measurement software permitting fast and efficient analysis without extra software tools. Replay reproduces recorded measured data. It can be started and stopped at any point of the recording. To make it easier to find critical points, the user can jump to certain (predefined) events in the file. It is also possible to select how many

seconds before and after the event the recording should be displayed in the replay window.

MapX for geographical evaluation

ROMES3 uses the GIS (geographical information system) tool MapX for the display of measured data. This tool inserts colour-coded numerical data and base station locations into a road map. This type of measured value display, which has become a standard, illustrates very clearly the radio network scenario. Both raster maps with pixel formats (BMP, JPG, TIF, etc) and vector maps can be used. Vector maps, as known generally, contain position information allocated to the individual objects, whereas raster maps have to be adjusted first. For this, ROMES3 offers a simple procedure: the unreferenced raster map is set up with reference to the test tour, i.e. specific points of the tour are assigned to specific points on the map. The rest is done by the referencing tool.

ROMES3 also offers the possibility of creating separate modules to implement special representations for the different types of transmissions. Handovers between cells can also be displayed.

Diagrams and tables

ROMES3 can display measured values versus time in any number of tables or 2D charts. The colours and time axis resolution (1 min to 24 h) with cursor, with one or more signals of diagrams can be freely configured at any time (even during a measurement).

Special views

To provide even more efficient analysis for the various transmission technologies used in a network, for example GSM or CDMA, ROMES3 is able to process data for visual representation in special, straightforward views. For example, there are GSM views presenting a measurement report, layer 2/3 messages or current system information.



Special views combined with diagram and map view for convenient analysis: here GSM measurements

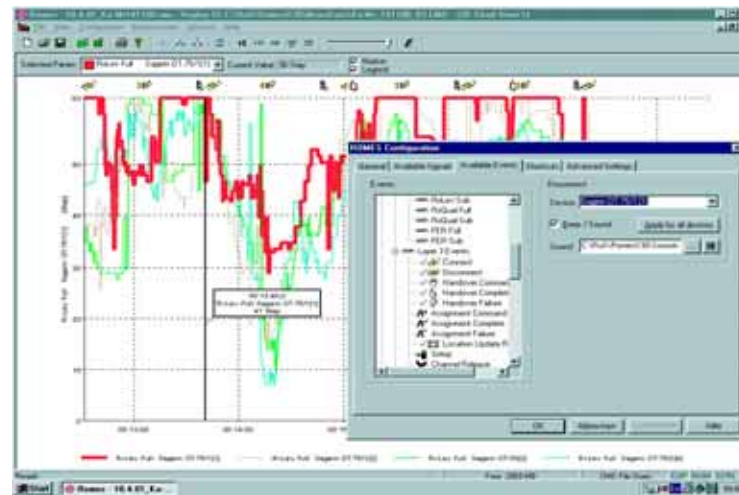

2D chart with event icons

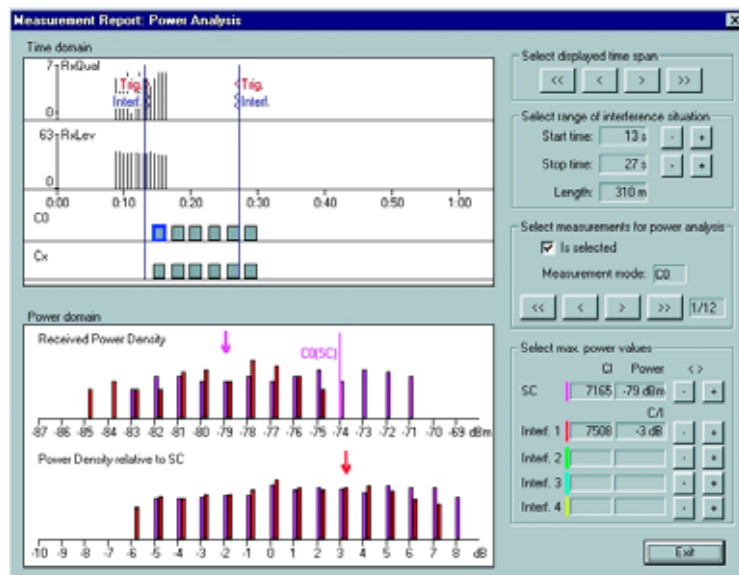

Power analyzer: interference analyzed in detail according to power, time, route and statistical distribution

Unique feature: mobile interference measurements

ROMES3 can very easily be adapted and extended for highly complex tasks such as interference measurements. To expand the measurement system for the acquisition of interference data (co-channel and adjacent-channel interference for both the CO and the CX (traffic) channel), all that is needed is extra signal processing hardware and driver software. A powerful tool is thus created that allows storage of a wide variety of measured data (from a test mobile, a test receiver, as well as interference data) in one and the same file and correlated in time and location. This eliminates the need for time-consuming combination of data from different files.

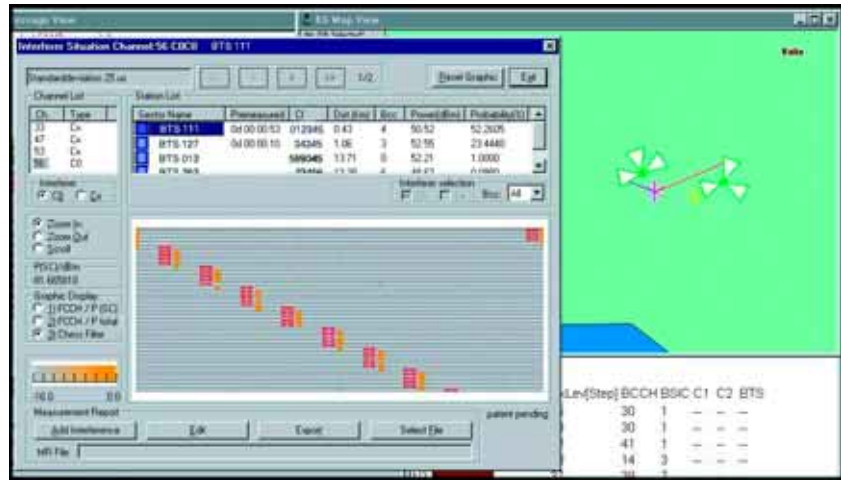

ROMES 3 can be expanded at minimum expense, e.g. to include mobile interference analysis

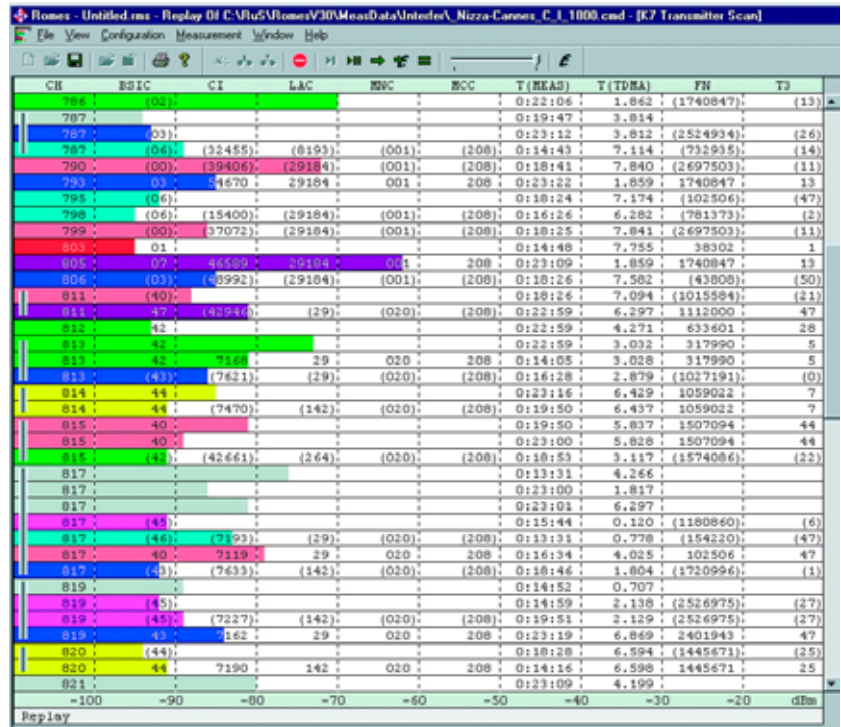

Transmitter scan: overview of current GSM channels with power levels and decoded associated network parameters (BSIC, CI LAC, MNC, MCC, etc.). Measurements are carried out by the test receiver even on mobiles affected by interference

Certified Environmental System
ISO 14001
REG. NO 1954

Certified Quality System
ISO 9001
DQS REG. NO 1954



...making the right connections.



ROHDE & SCHWARZ

ROHDE & SCHWARZ GmbH & Co. KG · Mühlendorfstraße 15 · 81671 München · Germany · P.O.B. 80 14 69 · 81614 München · Germany · Telephone +49 89 41 29-0
www.rohde-schwarz.com · Customer Support: Tel. +49 180 512 42 42, Fax +49 89 41 29-137 77, E-mail: CustomerSupport@rohde-schwarz.com